

O-RINGS AND STATIC SEALS

TECHNICAL PRINCIPLES

ISC O-Rings	550
Static Sealing	552
Dynamic Sealing	558
Further Technical Notes	565

PRODUCTS

Products	572
Design Types	573

ISC O-RINGS

Freudenberg Sealing Technologies (FST) ISC O-Rings are among the most demanded sealing components worldwide. With the ISC (International Specified Certified) seal of approval, FST proves consistency in terms of material attributes and compound formulas throughout the entire ISC O-Ring lifecycle.

REQUIREMENTS

- High resistance vis-à-vis a wide variety of applied media
- Superior temperature resistance
- High resistance to pressure, e.g. with hydraulics
- Certified and approved material qualities
- Resilience in dynamic applications
- Easy and economical fitting and maintenance procedures.



FEATURES

- State-of-the-art materials expertise and variety
- ISC certification with dependable material mixture ratios
- Friction-reducing special coatings for fitting and maintenance-friendly procedures
- High protection against twisting
- Very extensive offering of standard dimensions
- Large design variety (O-rings, X-rings, D-rings, Rectangular rings, Oval rings).

APPLICATION RANGE

ISC O-Rings from FST reliably perform their job in the most diverse range of industries. FST offers the most suitable solution for almost all industrial applications, solutions that precisely combine an optimum match of material and design.

- Valves
- Energy technology
- Industrial engines
- Medical technology
- Agricultural and construction machinery
- Power tools and household appliances
- Nautical engineering.



STATIC SEALING

The sealing effect of the ISC O-Ring is attributable to its axial or radial change of shape of its cross-section once installed. This change of shape is achieved by a corresponding designing of the installation space. The resultant reactive force provides the seal with the necessary contact pressure, which is additionally supported by pressure from the medium.

ISC O-Rings can be used for the sealing of stationary machine components, i.e. for static sealing. With the proper fitting and the correct choice of material, pressures of up to 1000 bar and more can be sealed. The dimensions of the installation space depend on the binding strength used and the respective application conditions. The groove dimensions reveal, depending on the ring thickness and application situation, a mean compression under pressure of 15% to 30%. With pulsating pressures the hardness of the ISC O-Ring material should not be less than 80 Shore A. Selection of the material hardness is dependent on the prevailing pressures and the specified tolerances (gap widths); → Fig. 8 and Fig. 9.

Note: the specified groove dimensions are recommendation and are taken from the nominal dimensions. In any case a calculation of tolerances (minimum/maximum) must be performed.

We recommend the following gradation:

Operating pressure	Material hardness
≤16 MPa	70 Shore A
>16 MPa	90 Shore A

Tbl. 1

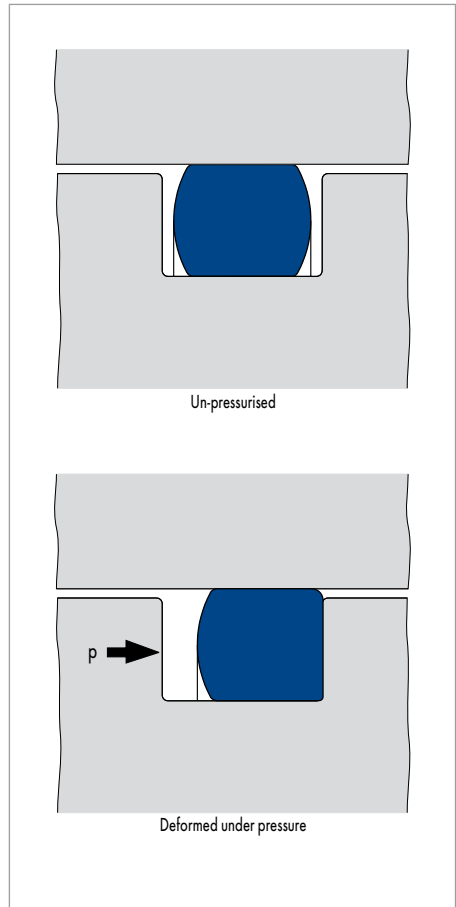

Fig. 1

INSTALLATION IN A RECTANGULAR GROOVE WITH RADIAL CHANGE OF SHAPE

For the sealing of mortices, sockets, bolts or covers with centering shoulders, ISC O-Rings are usually installed as in the figure below.

The cross-section of the ISC O-Ring (d_2) is radially deformed upon installation. Whether the mounting groove is cut into the inner or outer part depends on the processing and installation possibilities.

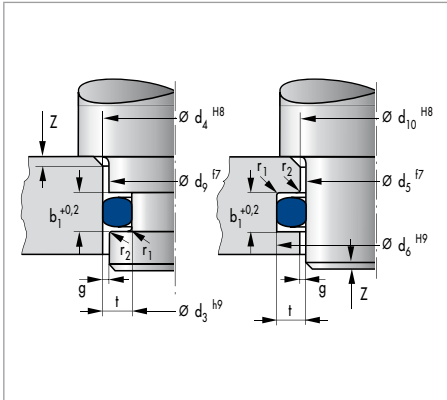

Fig. 2

With cover seals in hydraulic cylinders, installation as in (→ Fig. 3) is to be preferred in order that no gap enlargements occur on the non-pressurised side during the elastic expansion of the hydraulic lines under pressure load.

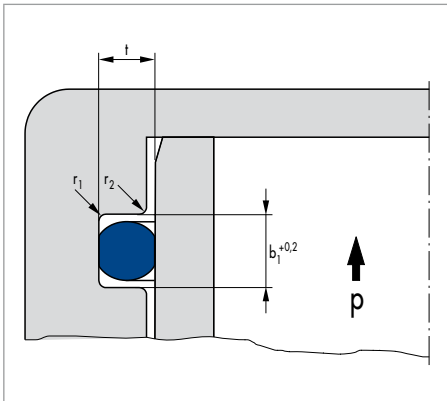
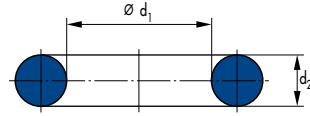

Fig. 3

Groove dimensions for an ISC O-Ring fitting in a rectangular groove with radial deformation



d_2	Seal surface distance t	Groove width $b_1 + 0,2$	Chamfer $15^\circ Z$
1,50	1,1 ±0,06	2,20	2,1
1,60	1,2 ±0,06	2,30	2,1
1,78	1,4 ±0,07	2,40	2,1
1,80	1,4 ±0,07	2,50	2,1
2,00	1,5 ±0,08	2,80	2,6
2,40	1,8 ±0,10	3,40	3,0
2,50	1,9 ±0,10	3,40	3,0
2,62	2,0 ±0,10	3,60	3,1
2,65	2,0 ±0,11	3,70	3,2
3,00	2,3 ±0,12	4,10	3,5
3,50	2,7 ±0,14	4,70	3,9
3,53	2,7 ±0,14	4,80	4,0
3,55	2,7 ±0,14	4,80	4,0
4,00	3,1 ±0,16	5,40	4,5
4,50	3,5 ±0,18	6,00	4,9
5,00	3,9 ±0,20	6,60	5,4
5,30	4,1 ±0,21	7,00	5,8
5,33	4,1 ±0,21	7,10	6,0
5,50	4,3 ±0,22	7,20	5,9
5,70	4,4 ±0,23	7,60	6,3
6,00	4,7 ±0,24	7,80	6,4
6,50	5,1 ±0,26	8,40	6,8
6,99	5,5 ±0,28	9,00	7,2
7,00	5,5 ±0,28	9,00	7,3
7,50	5,9 ±0,30	9,70	7,7
8,00	6,3 ±0,32	10,30	8,2
8,40	6,4 ±0,32	10,40	8,3
8,50	6,7 ±0,34	10,90	8,7
9,00	7,1 ±0,36	11,60	9,2

Tbl. 2

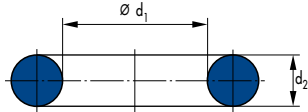
Groove dimensions for an ISC O-Ring fitting in a rectangular groove with radial deformation

d_2	Seal surface distance t	Groove width $b_1 + 0,2$	Chamfer $15^\circ Z$
9,50	$7,5 \pm 0,38$	12,20	9,6
10,00	$7,9 \pm 0,40$	12,80	10,1
10,50	$8,2 \pm 0,42$	13,60	11,0
11,00	$8,6 \pm 0,43$	14,10	11,3
11,50	$9,0 \pm 0,46$	14,70	11,8
12,00	$9,4 \pm 0,48$	15,50	12,4
12,50	$9,8 \pm 0,50$	16,10	12,8
13,00	$10,2 \pm 0,52$	16,70	13,3
13,50	$10,6 \pm 0,54$	17,30	13,8
14,00	$11,0 \pm 0,56$	17,90	14,2
14,50	$11,4 \pm 0,58$	18,50	14,7
15,00	$11,8 \pm 0,60$	19,10	15,1

Tbl. 2

INSTALLATION IN A RECTANGULAR GROOVE WITH AXIAL DEFORMATION

With flange and cover seals the cross-section of the ISC O-Ring is axially shaped. The pressure direction must be considered when specifying the ring dimensions or the installation space. Where external pressure is present, the ring inside diameter should correspond to the groove inside diameter or be dimensioned to be slightly smaller. Where internal pressure is present, the ring outside diameter should correspond to the groove outside diameter or be dimensioned to be slightly larger. This avoids that, due to swelling pressure, movement of the ISC O-Ring in the mounting groove results, thus leading to a greater deformation and wear.

Groove dimensions can be found in the following table.

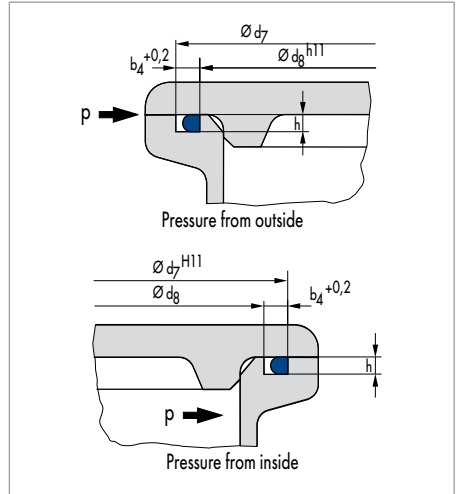
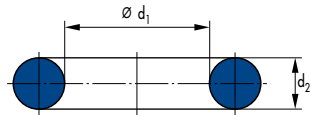

Fig. 4

Groove dimensions for an ISC O-Ring fitting in a rectangular groove with axial deformation

d_2	Groove depth h	Groove width $b_4 + 0,2$
1,50	$1,10 \pm 0,03$	2,20
1,60	$1,20 \pm 0,03$	2,20
1,78	$1,40 \pm 0,04$	2,40
1,80	$1,40 \pm 0,04$	2,40
2,00	$1,50 \pm 0,04$	2,80
2,40	$1,80 \pm 0,05$	3,30
2,50	$1,90 \pm 0,05$	3,40
2,62	$2,00 \pm 0,05$	3,50
2,65	$2,00 \pm 0,05$	3,60
3,00	$2,30 \pm 0,06$	4,00
3,50	$2,70 \pm 0,07$	4,60
3,53	$2,70 \pm 0,07$	4,60

Tbl. 3

Groove dimensions for an ISC O-Ring fitting in a rectangular groove with axial deformation		
d_2	Groove depth h	Groove width $b_4 + 0,2$
3,55	2,70 ±0,07	4,60
4,00	3,10 ±0,08	5,20
4,50	3,50 ±0,09	5,80
5,00	3,90 ±0,10	6,40
5,30	4,10 ±0,11	6,80
5,33	4,10 ±0,11	7,00
5,50	4,30 ±0,11	7,00
5,70	4,40 ±0,11	7,40
6,00	4,70 ±0,12	7,60
6,50	5,10 ±0,13	8,20
6,99	5,50 ±0,14	8,80
7,00	5,50 ±0,14	8,80
7,50	5,90 ±0,15	9,40
8,00	6,30 ±0,16	10,00
8,40	6,97 ±0,10	10,78
8,50	6,70 ±0,17	10,70
9,00	7,10 ±0,18	11,30
9,50	7,50 ±0,19	11,80
10,00	7,90 ±0,20	12,40
10,50	8,20 ±0,21	13,30
11,00	9,13 ±0,10	14,08
11,50	9,55 ±0,10	14,69
12,00	9,40 ±0,24	15,10
12,50	10,38 ±0,10	15,92
13,00	10,20 ±0,26	16,20
13,50	11,21 ±0,10	17,15
14,00	11,62 ±0,10	17,77
14,50	12,04 ±0,10	18,38
15,00	11,80 ±0,30	18,60

Tbl. 3

INSTALLATION IN A TRIANGULAR GROOVE

Mounting spaces with a triangular form are sometimes used with threaded flanges and covers.

It is, however, difficult to manufacture them with exact dimensions.

As the sealing function of the ISC O-Ring depends on the exact design of the mounting groove, it is imperative that the dimensions and tolerances stated in the following table be adhered to. Fitting into a rectangular groove is preferred, however.

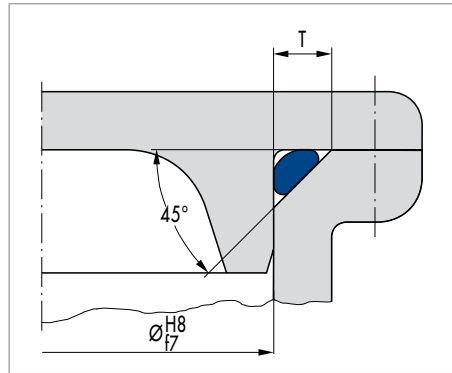
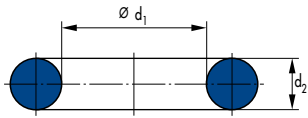

Fig. 5

ISC O-Ring groove dimensions for installation in a triangular groove	
Groove dimensions	
d_2	T
1,00	1,40 ±0,04
1,50	2,10 ±0,06
1,60	2,30 ±0,06
1,78	2,50 ±0,07
1,80	2,60 ±0,07
2,00	2,90 ±0,08
2,40	3,50 ±0,10
2,50	3,60 ±0,10

Tbl. 4

ISC O-Ring groove dimensions for installation
in a triangular groove

Groove dimensions

d_2	T
2,62	3,80 ±0,10
2,65	3,80 ±0,11
3,00	4,30 ±0,12
3,50	5,10 ±0,14
3,53	5,10 ±0,14
3,55	5,10 ±0,14
4,00	5,80 ±0,16
4,50	6,50 ±0,18
5,00	7,30 ±0,20
5,30	7,70 ±0,21
5,33	7,70 ±0,21
5,50	8,00 ±0,22
5,70	8,30 ±0,23
6,00	8,70 ±0,24
6,50	9,50 ±0,26
6,99	10,20 ±0,28
7,00	10,20 ±0,28
7,50	11,00 ±0,30
8,00	11,70 ±0,32
8,40	11,51 ±0,40
8,50	12,40 ±0,34
9,00	13,20 ±0,36
9,50	13,90 ±0,38
10,00	14,70 ±0,40
10,50	15,40 ±0,42
11,00	15,07 ±0,40
11,50	15,76 ±0,40
12,00	17,60 ±0,48

Tbl. 4

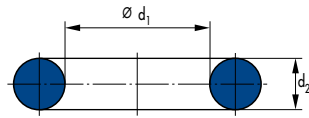
 ISC O-Ring groove dimensions for installation
in a triangular groove

Groove dimensions

d_2	T
12,50	17,13 ±0,50
13,00	19,10 ±0,52
13,50	18,50 ±0,50
14,00	19,18 ±0,50
14,50	19,87 ±0,50
15,00	22,10 ±0,60

Tbl. 4

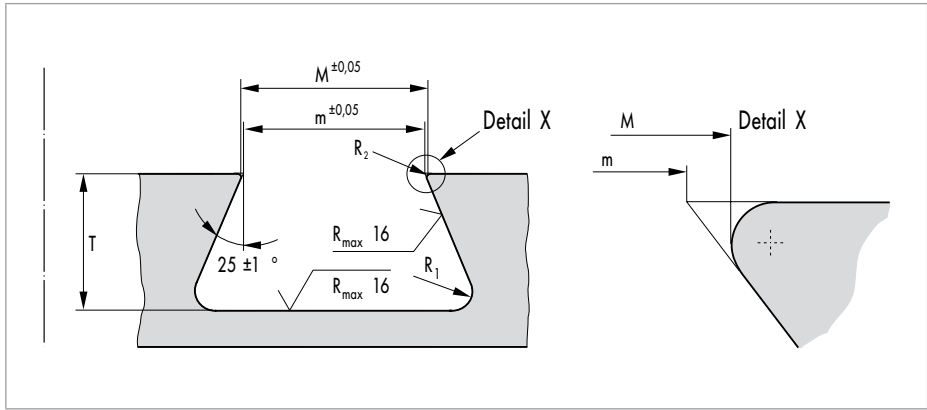

Fig. 6

INSTALLATION IN A TRAPEZOIDAL GROOVE WITH AXIAL DEFORMATION

The trapezoidal groove is used when the ISC O-Ring is to be held firmly in the housing groove. Due to the difficult manufacture of the groove, it is recommended to only use this application with a ring thickness of 3,5 mm or thicker. The inside diameter of the ISC O-Ring is derived from the mean groove diameter minus the ring thickness.

Groove dimensions for an ISC O-Ring fitting in a trapezoidal groove with axial deformation

Groove dimensions					
d_2	T	m	M	R_1	R_2
3,53	2,9 ± 0,07	2,9	3,1	0,6	0,2
3,55	2,9 ± 0,07	2,9	3,1	0,6	0,2
4,00	3,3 ± 0,08	3,3	3,5	0,7	0,2
4,50	3,7 ± 0,09	3,7	4,0	0,7	0,3
5,00	4,1 ± 0,10	4,1	4,4	0,8	0,3
5,30	4,4 ± 0,11	4,4	4,7	0,9	0,3

Tbl. 5

Groove dimensions for an ISC O-Ring fitting in a trapezoidal groove with axial deformation

Groove dimensions					
d_2	T	m	M	R_1	R_2
5,33	4,4 ± 0,11	4,4	4,7	0,9	0,3
5,50	4,5 ± 0,11	4,5	4,8	0,9	0,3
5,70	4,7 ± 0,11	4,7	5,0	0,9	0,3
6,00	5,0 ± 0,12	5,0	5,5	1,0	0,4
6,50	5,4 ± 0,13	5,4	5,9	1,1	0,4
7,00	5,8 ± 0,14	5,8	6,3	1,2	0,4
7,50	6,2 ± 0,15	6,2	6,7	1,2	0,4
8,00	6,7 ± 0,16	6,7	7,3	1,3	0,5
8,40	7,25	7,3	7,9	1,5	0,5
8,50	7,1 ± 0,17	7,1	7,7	1,4	0,5
9,00	7,5 ± 0,18	7,5	8,1	1,5	0,5
9,50	7,9 ± 0,19	7,9	8,6	1,6	0,6
10,00	8,3 ± 0,20	8,3	9,0	1,7	0,6

Tbl. 5

DYNAMIC SEALING

With dynamic sealing, a distinction must be made between hydraulics and pneumatics in ISC O-Ring applications. Due to the friction resistance, the deformation is minimised compared with static seals. Sufficient lubrication from the medium to be sealed with hydraulics, or by means of an aerosol lubricator with pneumatics, reduces losses due to friction and wear.

We recommend the following gradation:

Operating pressure	Material hardness
≤6,3 MPa	70 Shore A
>6,3 MPa	90 Shore A

Tbl. 6

HYDRAULICS – AXIAL MOVEMENT

With hydraulics, ISC O-Rings are only used as rod or piston seals where there is a small installation space for a sealing component, where short stroke distances with relatively infrequent stroke cycles occur and no absolute sealing effect is required.

The minimum cross-section deformation should not exceed 6%. This can be determined by a comparison of the greatest groove depth and smallest ring thickness in terms of tolerances.

The installation dimensions can be found in the following table. The dimensions for the length of the facet Z are minimum values.

HYDRAULICS – OSCILLATING MOVEMENTS

ISC O-Rings can also be used for sealing shafts with a reciprocating movement and at the same time with a turning or pivoting motion. The installation dimensions for these can also be found in the following table.

ISC O-Ring groove dimensions for fitting in hydraulics with axial/oscillating movements

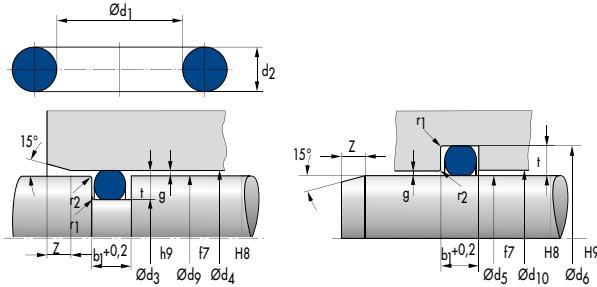

d_2	Groove depth t	Groove width b_1	Chamfer 15° Z
1,50	1,3 ±0,03	1,8	1,2
1,78	1,5 ±0,04	2,2	1,5
1,80	1,5 ±0,04	2,2	1,6
2,00	1,7 ±0,04	2,4	1,7
2,40	2,1 ±0,05	2,8	1,7
2,50	2,2 ±0,05	2,9	1,7
2,62	2,3 ±0,05	3,0	1,8
2,65	2,3 ±0,05	3,1	1,9
3,00	2,6 ±0,06	3,5	2,1
3,50	3,1 ±0,07	4,0	2,2
3,53	3,1 ±0,07	4,0	2,3
3,55	3,1 ±0,07	4,0	2,3
4,00	3,5 ±0,08	4,6	2,7
4,50	3,9 ±0,09	5,2	3,1
5,00	4,4 ±0,10	5,7	3,1
5,30	4,7 ±0,11	5,9	3,2
5,33	4,7 ±0,11	6,0	3,4
5,50	4,8 ±0,11	6,3	3,6
5,70	5,0 ±0,11	6,5	3,6
6,00	5,3 ±0,12	6,7	3,7
6,50	5,7 ±0,13	7,3	4,1
6,99	6,2 ±0,14	7,8	4,1
7,00	6,2 ±0,14	7,8	4,1
7,50	6,6 ±0,15	8,4	4,6
8,00	7,1 ±0,16	8,9	4,6
8,50	7,5 ±0,17	9,5	5,1
9,00	7,9 ±0,18	10,1	5,5
9,50	8,4 ±0,19	10,5	5,5
10,00	8,8 ±0,20	11,1	5,9

Tbl. 7

HYDRAULICS – ROTATING MOTION

The sealing of a rotating shaft should only be attempted with an ISC O-Ring if there is no room for the installation of an effective seal and the operating conditions are not severe. Circumferential speeds of up to approx. 4 m/s can be handled with non-pressurised media, insofar as no greater demands are made with regard to the service life and sealing effect. A Simmerring is in any case more dependable. The ISC O-Ring is to be installed in the stationary outer housing part. The ISC O-Ring inside diameter should not be more than approx. 5% larger in its installed position than the shaft to be sealed. It must be tightly packed when being installed. In order to avoid warping in its groove of the tightly packed, installed ISC O-Ring, the groove width may only be slightly larger than the maximum ring thickness.

Sufficient lubrication and good heat dissipation must be provided for. The hardness of the ISC O-Ring material may not be less than 80 Shore A. The shaft to be sealed must be hardened on the surface to approx. 60 HRC. In the fitting area of the ISC O-Ring, the shaft should be ground non-oriented in the plunge-cut and the surface roughness should be $R_{\max} \leq 2 \mu\text{m}$.

Recommendation d_1	Ring strength d_2
... 9	1,78
of 8 ... 19	2,40 and 2,62
of 18 ... 40	3,00 and 3,53
of 37 ... 130	5,33 and 5,70
of 110 ... 150	6,99

Tbl. 8

Groove dimensions for ISC O-Ring fitting for hydraulics – rotating movements

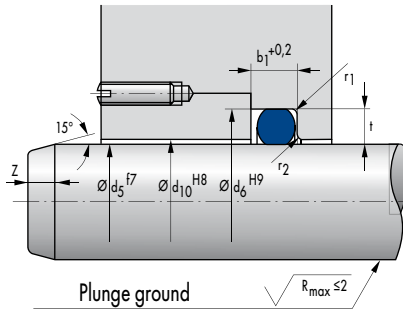

d_2	Groove depth t	Groove width $b_1 + 0,2$	Chamfer 15° Z
1,78	1,6 ± 0,04	2,0	1,2
1,80	1,6 ± 0,04	2,1	1,2
2,40	2,2 ± 0,05	2,7	1,3
2,62	2,4 ± 0,05	2,9	1,4
2,65	2,4 ± 0,05	3,0	1,5
3,00	2,8 ± 0,06	3,2	1,5
3,53	3,3 ± 0,07	3,9	1,9
3,55	3,3 ± 0,07	3,9	1,9
5,30	4,9 ± 0,11	5,7	2,4
5,33	4,9 ± 0,11	5,8	2,6
5,70	5,3 ± 0,11	6,1	2,8
6,99	6,5 ± 0,14	7,4	3,0
7,00	6,5 ± 0,14	7,4	3,0

Tbl. 9

Pneumatics – axial movement – radial ISC O-Ring compression under pressure

In order to ensure low losses due to friction and long operating times in spite of inadequate lubrication possibilities, the deformation of the cross-section is

kept low. The deformation is minimised to between 2% and 6%, depending on the ring thickness.

The dimensions for the length of the facet are minimum values.

ISC O-Ring groove dimensions for fitting in pneumatics / axial movement / radial compression under pressure

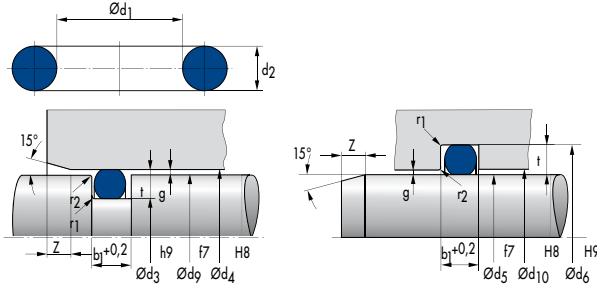

d_2	Groove depth t	Groove width $b_1 + 0,2$	Chamfer $15^\circ Z$
1,50	1,3 ±0,03	1,8	1,2
1,78	1,6 ±0,04	2,0	1,2
1,80	1,6 ±0,04	2,1	1,2
2,00	1,8 ±0,04	2,3	1,3
2,40	2,2 ±0,05	2,7	1,3
2,50	2,3 ±0,05	2,8	1,3
2,62	2,4 ±0,05	2,9	1,4
2,65	2,4 ±0,05	3,0	1,5
3,00	2,7 ±0,06	3,4	1,8
3,50	3,2 ±0,07	3,8	1,8
3,53	3,2 ±0,07	3,9	1,9
3,55	3,3 ±0,07	3,9	2,0
4,00	3,6 ±0,08	4,5	2,3
4,50	4,1 ±0,09	4,9	2,4
5,00	4,6 ±0,10	5,4	2,4
5,30	4,9 ±0,11	5,7	2,4
5,33	4,9 ±0,11	5,8	2,6
5,50	5,0 ±0,11	6,0	2,9
5,70	5,2 ±0,11	6,2	2,9
6,00	5,5 ±0,12	6,5	2,9
6,50	6,0 ±0,13	7,0	3,0
6,99	6,4 ±0,14	7,5	3,3
7,00	6,4 ±0,14	7,5	3,4
7,50	6,9 ±0,15	8,0	3,4
8,00	7,4 ±0,16	8,5	3,5
8,50	7,8 ±0,17	9,1	4,0
9,00	8,3 ±0,18	9,6	4,0
9,50	8,8 ±0,19	10,1	4,0
10,00	9,2 ±0,20	10,6	4,5

Tbl. 10

Pneumatics – axial movement – without ISC O-Ring compression under pressure (float-mounted fitting)

The float-mounted fitting is especially suitable for the sealing of pistons. The cross-section of the ISC O-Ring is not deformed by this. The advantage of this type of installation lies in its ease of movement and the minimal wear of the ISC O-Ring. During the pressure build-up a little bit of air can escape before the ISC O-Ring closes the gap between the piston and cylinder wall.

When determining the ISC O-Ring the following should be considered:

The outside diameter of the ISC O-Ring should be 2% - 5% greater than that of the cylinder diameter.
The inside diameter of the ISC O-Ring may not abut against groove base.

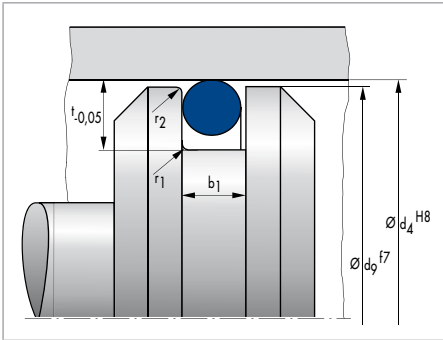
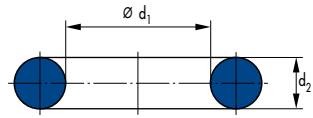

Fig. 7

ISC O-Ring groove dimensions for fitting in pneumatics - axial movement - without compression under pressure



d_2	Groove depth $t + 0,2$	Groove width $b_1 + 0,2$
1,78	2,1	2,1
1,80	2,1	2,1
2,40	2,7	2,8
2,62	3,0	3,0
2,65	3,0	3,1
3,00	3,4	3,5
3,53	4,0	4,0
3,55	4,0	4,0
5,30	6,0	6,0
5,33	6,0	6,1
5,70	6,4	6,5
6,99	7,9	7,9
7,00	7,9	7,9

Tbl. 11

Processing

If possible, the mounting grooves for ISC O-Rings should be square. If necessary due to reasons of manufacturing compatibility, the flanks can be angled up to 5° .

The surface area of the mounting groove must always be larger than that of the ISC O-Ring cross-section ($\approx 25\%$) in order that the pressure can be distributed across a relatively large portion of the ring surface and so that there is sufficient room in the installation space for a possible increase in volume caused chemical influences.

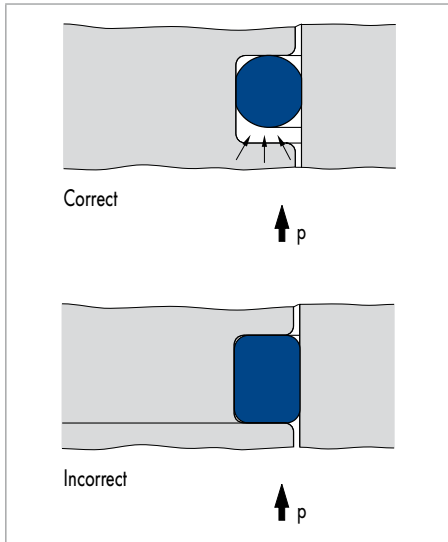

Fig. 8

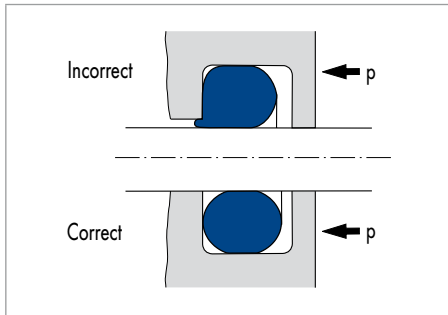

Fig. 9

FITS AND GAP WIDTHS

The fits stated in the installation lists must be adhered to. Any changes that could lead to an enlargement of the gap width are to be avoided. With too large of a gap, the danger exists that the ISC O-Ring under pressure will be pressed into it and destroyed.

The values for the permissible gap widths can be found in → Diagram 1 and → Diagram 2.

Gap widths for stationary machine components

When using back-up rings made of PTFE, gap widths of up to 0,3 mm can be bridged at operating pressures of up to 40 MPa.

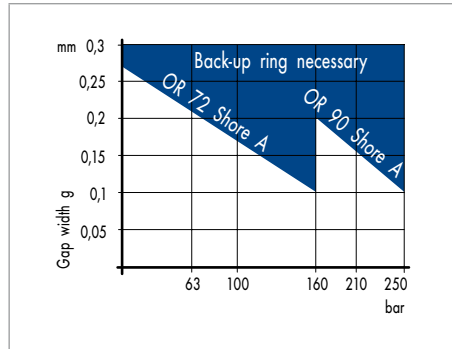

Diagram 1

Gap widths for axially moving machine parts

When using back-up rings made of PTFE, gap widths of up to 0,3 mm can be bridged at operating pressures of up to 25 MPa.

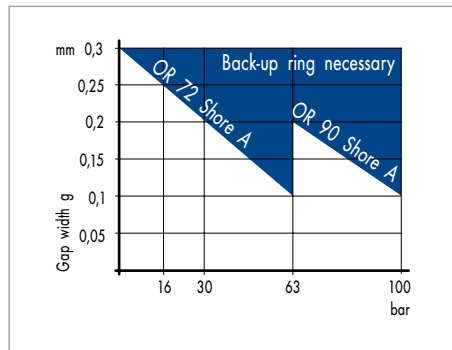
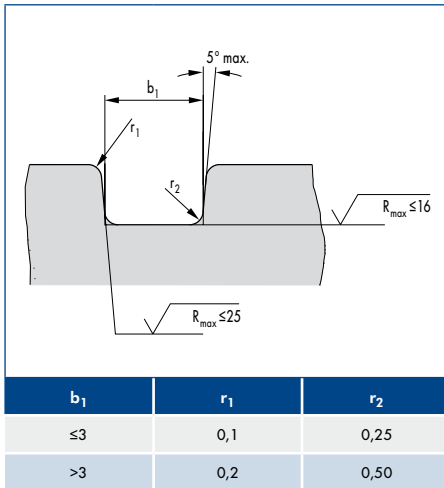

Diagram 2

SURFACES

Groove	Application		R_a	R_z	
Groove base and flanks	Static	Under non-pulsating pressure	Axial (planar)	3,2	12,5
			Radial (cylindrical)	1,6	6,3
	Dynamic	Under pulsating pressure		1,6	6,3
		With SR (back-up ring)		1,6	6,3
		Without SR (back-up ring)		0,8	3,2
Rod and cylinder wall	Static	Under non-pulsating pressure		1,6	6,3
		Under pulsating pressure		0,8	3,2
	Dynamic		0,4	1,6	
Lead-in chamfer			3,2	12,5	

Tbl. 12



Tbl. 13

With pulsating pressure, the surface roughness for the mounting groove must be more finely finished. Instead of the curvature r_2 at the base of the mounting groove, an equally large facet with an angle of 45° can be chosen. All machine parts that come into contact with the ISC O-Ring must be carefully de-burred. All foreign material must be removed before fitting. Steel is usually used for rods and pipes. Clean, smooth and non-porous cast iron is also suitable. Due to their softness, aluminium, bronze or brass and stainless steels show increased wear as a result of dynamic loading. They are, however, also used for specific application situations.

Facets of the rod or the housing

Due to fitting-related reasons, the rod and the housing (max. angle 15°) should be bevelled.

The transitions should be carefully rounded off.

The dimensions for the depth of the facet Z are minimum values and must be increased for shallower angles.

The ISC O-Ring should also abut against the bevel even with extreme tolerances. Contact with the forward edge can lead to ISC O-Ring damage.

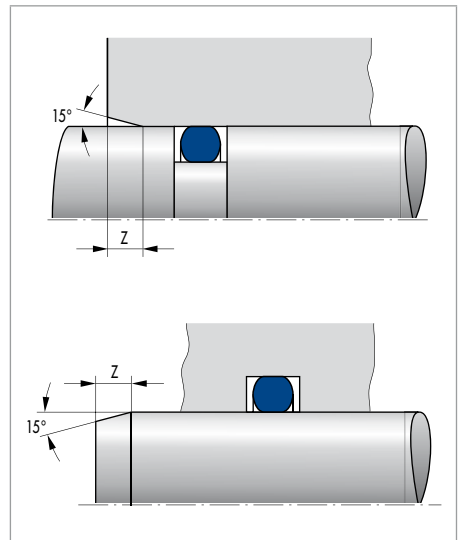

Fig. 10 Edges rounded off burr-free

FURTHER TECHNICAL NOTES

FITTING

The entire system should be cleansed of dirt and processing residue prior to fitting of the ISC O-Rings. ISC O-Rings should not be pulled over sharp edges, crooked shafts, threads, grooves, etc. It is recommendable to cover the sharp transitions when mounting in order to avoid damage.

The ISC O-Ring may not be positioned distorted – twisted – in the mounting groove. A brief elastic expansion is permissible when mounting. The ring must, however, be allowed time to return to its original shape after fitting. Caution is urged during the fitting of piston or shaft seals with an outside diameter of less than 10 mm due to the greater relative expansion.

The use of a pilot shaft or a mounting sleeve is recommended.

ELONGATION AND COMPRESSION

The permanent elastic expansion should not exceed 6%, as otherwise too great of a diminution and a too extreme of a flattening out of the ISC O-Ring cross-section will occur → Diagram 3.

The compression of the ISC O-Ring should not exceed 3%, as otherwise there is a danger of the ring warping and shearing off when mounting.

The stated values for elongation and compression are theoretical values that are not always adhered to in practical applications. Especially with greater elongations, the ISC O-Ring installation space must be modified accordingly in order to adequately allow for cross-sectional changing of shape under pressure.

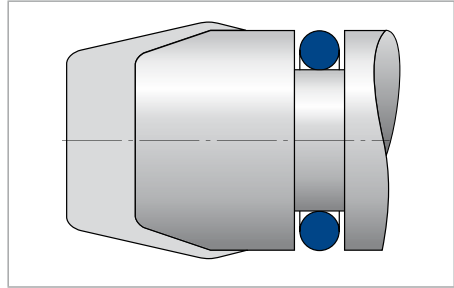

Fig. 11

Forces required for a cross-sectional shape change under pressure

The values stated in → Diagram 4 can be applied to other materials from Freudenberg Sealing Technologies, according to the Shore hardness, for an estimation of the order of magnitude. The necessary force for changing shape depends on the material hardness. Utilising the same material,

it rises linearly with increases in ring thickness.

The values are to be viewed as reference values, according to which the overall force to be used for the static fitting of ISC O-Rings can be determined. They should not, however, be used to determine the frictional forces for the dynamic pressurising of ISC O-Rings.

(The effects of the environmental conditions such as tolerances, temperatures and coefficient of friction are too great to be able to make a definitive statement.)

TOLERANCES

ISC O-Ring are manufactured to extremely close tolerance levels, as specified in DIN 3771. The stated values are only valid for ISC O-Rings made of the standard material 72 NBR 872.

With FST materials having a different material base or a different hardness, deviations from the nominal dimensions could arise as a result of shrinkage. These, however, are normally so small that they have no effect on the intended ISC O-Ring function.

The inside diameter tolerances can be found in the tool list → Fig. 16. For intermediate sizes the next higher tolerance level is applicable.

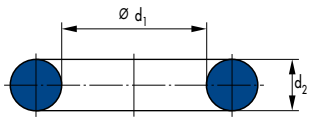

Ring thickness d_2		Tolerance
Greater than	Up to	
	1,80	$\pm 0,08$
1,80	2,65	$\pm 0,09$
2,65	3,55	$\pm 0,10$
3,55	5,30	$\pm 0,13$
5,30	7,00	$\pm 0,15$
7,00	8,00	$\pm 0,16$
8,00	10,00	$\pm 0,18$
10,00	15,00	$\pm 0,22$

Tbl. 14

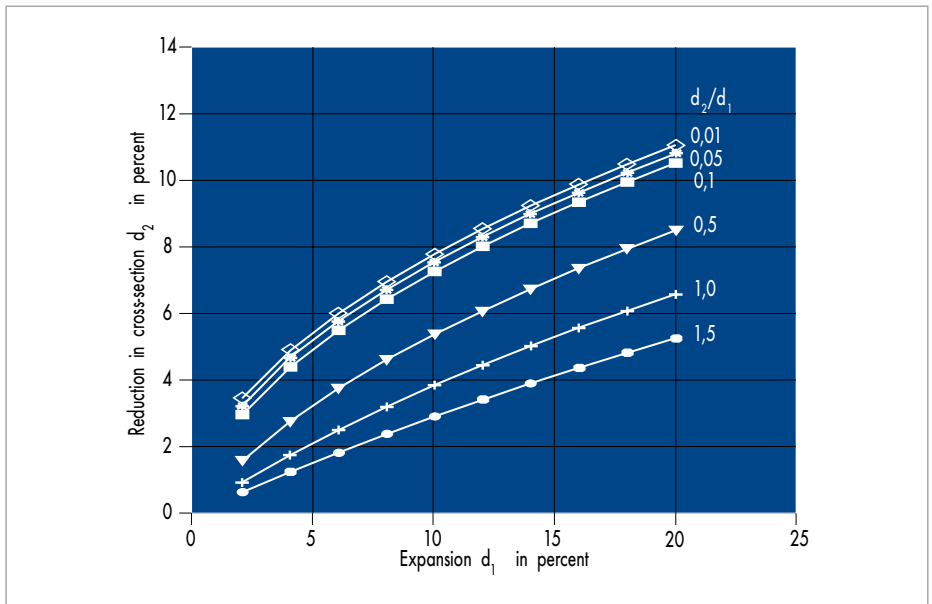

Diagram 3 Reduction of the cross-sectional area with elastic expansion of the inside diameter for different d_2/d_1 relationships

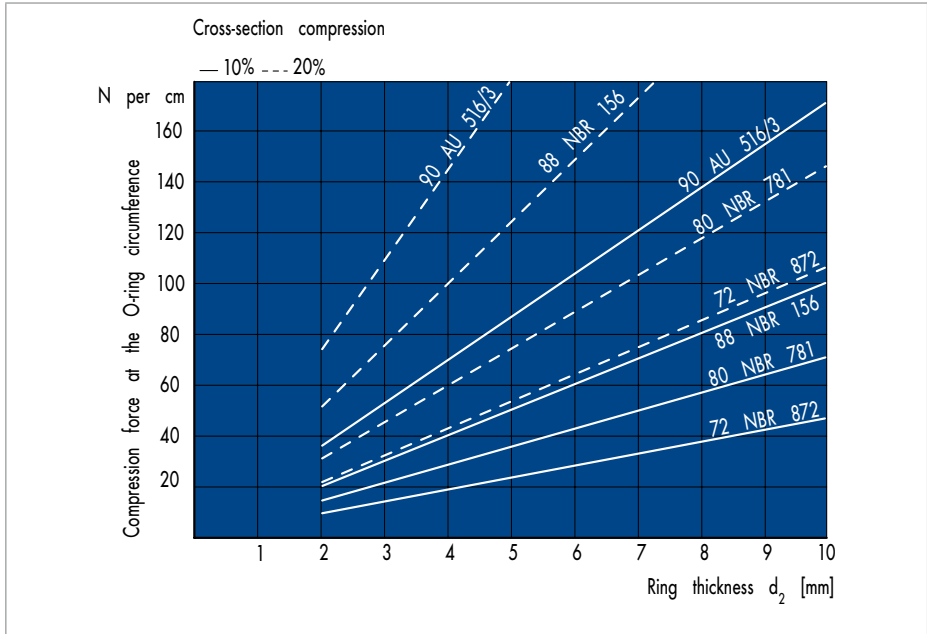

Diagram 4 Necessary force of pressure at 10% and 20% cross-sectional shape change under pressure

NOTES ON DISPOSAL

Rubber parts or remains can be disposed of, in line with local regulations and disposal procedures, at a waste disposal facility or burned in a suitable plant.

Name of waste: Rubber waste, Key No. 57501.

MEASUREMENT METHODS

A conical test mandrel (taper 1:10 DIN 254) is used to measure the ring-inside diameter d_1 . A scale is engraved on the surface shell, the increments of which correspond to a diameter variance of 0,1 mm. Measurement of the ring thickness d_2 is performed with a calliper. The increments on the dial gauge correspond to 0,01 mm. The contact pressure between the plate-shaped calliper surfaces has a size of 1 N.

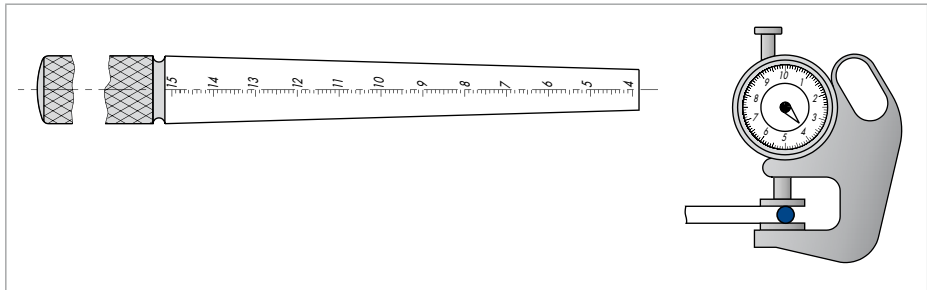

Fig. 12

GRADE ATTRIBUTES ACCORDING TO DIN 3771

ISC O-Rings are supplied in two different design implementation qualities to cover all requirement situations that arise with practical applications.

- Grade attribute N (Normal quality), quality limit range AQL 1.0 or by agreement.



These ISC O-Rings fulfil very high quality demands and are suitable for all conventional application situations. It is irrelevant whether these involve static or dynamic seals.

ISC O-Rings in standard quality are kept in stock.

- Grade attribute S (Special quality), quality limit range AQL 0.65 or by agreement.

These ISC O-Rings are only considered for application situations in which the highest demands for design implementation and sealing effectiveness are made.

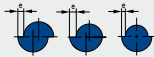
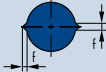
ISC O-Ring in special quality grades require significantly greater manufacturing and quality assurance efforts than ISC O-Rings in normal quality. Thus, they are also significantly more expensive. They must be ordered with the note "ISC O-Rings according to grade attribute S" while at the same time specifying the intended application. ISC O-Rings in special quality grades are not kept in stock. Normal quality grade ISC O-Rings and the special quality grades are distinguished by their permissible attribute designations. The permissible tolerance levels are the same for both design implementation grades. The listed attribute designations are to be considered as recommended values for both manufacturers and users. Visual inspection is made of the attribute designations for the different grade attributes as a part of the manufacturing and control processes. Limit samples serve as the basis for this test, which is established according to → Tbl. 15. Special arrangements are possible for special applications.

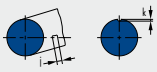
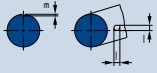
Type of deviation	Diagrammatic presentation	Dimensions	Grade attribute N					Grade attribute S				
			d2 according to DIN 3771, Part 1					d2 according to DIN 3771, Part 10				
			1,80	2,65	3,55	5,30	7,00	1,80	2,65	3,55	5,30	7,00
Largest size												
Offset and shape deviations		e	0,08	0,10	0,13	0,15	0,15	0,08	0,08	0,10	0,12	0,13
Bead, burs, offset combined		f	0,10	0,12	0,14	0,16	0,18	0,10	0,10	0,13	0,16	0,15
Notch		g	0,18	0,27	0,36	0,53	0,70	0,10	0,15	0,20	0,20	0,30
		h	0,08	0,08	0,10	0,10	0,13	0,08	0,08	0,10	0,10	0,13
Deburred area		-	Deviations from round cross-sections are permissible if the flattened area goes seamlessly into the curvature and lies within the permissible tolerance levels.									
Flow marks (radial expansion is not permissible)		i	0,05 x d ₁ or ¹⁾					0,03 x d ₁ or ¹⁾				
		k	1,5	1,5	6,5	6,5	6,5	1,5	1,5	5	5	5
Pits, indentations		l	0,60	0,80	1,00	1,30	1,70	0,15	0,25	0,40	0,63	1,00
		Depth	0,08	0,08	0,10	0,10	0,13	0,08	0,08	0,10	0,10	0,13
Foreign material	-	-	Not permissible									

¹⁾ Depending on which number is larger

Tbl. 15 Grade attributes according to DIN 3771 – Part 4

TOOL LIST ACCORDING TO DIN 3771

ISC O-Rings specified according to DIN 3771, with inside diameter, cross-sections and permissible deviations for general industrial applications are marked (X) in the table.

Standard series tools are available for the dimensions identified with ¹⁾. The tools are designed for the standard material 72 NBR 872. Nominal dimension deviations at d_1 and d_2 are to be expected for other materials.

The number of tools is constantly being expanded.

d_1		d_2				
		$\pm 0,08$	$\pm 0,09$	$\pm 0,10$	$\pm 0,13$	$\pm 0,15$
	Permis. dev.	1,80	2,65	3,55	5,30	7,00
1,80	$\pm 0,13$	● ¹⁾				
2,00	$\pm 0,13$	● ¹⁾				
2,24	$\pm 0,13$	●				
2,50	$\pm 0,13$	● ¹⁾				
2,80	$\pm 0,14$	● ¹⁾				
3,15	$\pm 0,14$	● ¹⁾				
3,55	$\pm 0,14$	● ¹⁾				
3,75	$\pm 0,14$	● ¹⁾				
4,00	$\pm 0,14$	● ¹⁾				
4,50	$\pm 0,14$	● ¹⁾				
4,87	$\pm 0,15$	● ¹⁾				
5,00	$\pm 0,15$	● ¹⁾				
5,15	$\pm 0,15$	● ¹⁾				
5,30	$\pm 0,15$	● ¹⁾				
5,60	$\pm 0,15$	●				
6,00	$\pm 0,15$	● ¹⁾				
6,30	$\pm 0,15$	● ¹⁾				
6,70	$\pm 0,16$	● ¹⁾				
6,90	$\pm 0,16$	● ¹⁾				
7,10	$\pm 0,16$	●				
7,50	$\pm 0,16$	● ¹⁾				

¹⁾ Standard series tools available

Tbl. 16

d_1	d_2					
	$\pm 0,08$	$\pm 0,09$	$\pm 0,10$	$\pm 0,13$	$\pm 0,15$	
	Permis. dev.	1,80	2,65	3,55	5,30	7,00
8,00	$\pm 0,16$	● ¹⁾				
8,50	$\pm 0,16$	●				
8,76	$\pm 0,17$	● ¹⁾				
9,00	$\pm 0,17$	●				
9,50	$\pm 0,17$	●				
10,00	$\pm 0,17$	●				
10,60	$\pm 0,18$	●				
11,20	$\pm 0,18$	● ¹⁾				
11,80	$\pm 0,19$	●				
12,50	$\pm 0,19$	● ¹⁾				
13,20	$\pm 0,19$	●				
14,00	$\pm 0,19$	● ¹⁾	● ¹⁾			
15,00	$\pm 0,20$	● ¹⁾	● ¹⁾			
16,00	$\pm 0,20$	●	●			
17,00	$\pm 0,21$	● ¹⁾	● ¹⁾			
18,00	$\pm 0,21$		● ¹⁾	● ¹⁾		
19,00	$\pm 0,22$		● ¹⁾	● ¹⁾		
20,00	$\pm 0,22$		● ¹⁾	● ¹⁾		
21,20	$\pm 0,23$		●	● ¹⁾		
22,40	$\pm 0,24$		● ¹⁾	●		
23,60	$\pm 0,24$		● ¹⁾	● ¹⁾		
25,00	$\pm 0,25$		● ¹⁾	● ¹⁾		
25,80	$\pm 0,26$		●	● ¹⁾		
26,50	$\pm 0,26$		● ¹⁾	● ¹⁾		
28,00	$\pm 0,28$		●	●		
30,00	$\pm 0,29$		● ¹⁾	● ¹⁾		
31,50	$\pm 0,31$		● ¹⁾	● ¹⁾		
32,50	$\pm 0,32$		●	●		
33,50	$\pm 0,32$		●	●		
34,50	$\pm 0,33$		● ¹⁾	● ¹⁾		
35,50	$\pm 0,34$		●	●		
36,50	$\pm 0,35$		● ¹⁾	● ¹⁾		

¹⁾ Standard series tools available

Tbl. 16

d ₁		d ₂				
		±0,08	±0,09	±0,10	±0,13	±0,15
	Permis. dev.	1,80	2,65	3,55	5,30	7,00
37,50	±0,36		● ¹⁾	● ¹⁾		
38,70	±0,37		●	● ¹⁾		
40,00	±0,38			●	●	
41,20	±0,39			●	●	
42,50	±0,40			●	● ¹⁾	
43,70	±0,41			● ¹⁾	● ¹⁾	
45,00	±0,42			● ¹⁾	●	
46,20	±0,43			● ¹⁾	● ¹⁾	
47,50	±0,44			● ¹⁾	●	
48,70	±0,45			●	●	
50,00	±0,46			●	● ¹⁾	
51,50	±0,47			●	●	
53,00	±0,48			●	● ¹⁾	
54,50	±0,50			●	●	
56,00	±0,51			● ¹⁾	● ¹⁾	
58,00	±0,52			● ¹⁾	● ¹⁾	
60,00	±0,54			● ¹⁾	● ¹⁾	
61,50	±0,55			● ¹⁾	●	
63,00	±0,56			● ¹⁾	● ¹⁾	
65,00	±0,58			● ¹⁾	●	
67,00	±0,59			● ¹⁾	●	
69,00	±0,61			● ¹⁾	●	
71,00	±0,63			●	●	
73,00	±0,64			● ¹⁾	● ¹⁾	
75,00	±0,66			● ¹⁾	●	
77,50	±0,67			●	●	
80,00	±0,69			●	● ¹⁾	
82,50	±0,71			● ¹⁾	● ¹⁾	
85,00	±0,73			● ¹⁾	● ¹⁾	
87,50	±0,75			●	●	
90,00	±0,77			● ¹⁾	● ¹⁾	
92,50	±0,79			●	● ¹⁾	

¹⁾ Standard series tools available

Tbl. 16

d ₁		d ₂				
		±0,08	±0,09	±0,10	±0,13	±0,15
	Permis. dev.	1,80	2,65	3,55	5,30	7,00
95,00	±0,81			● ¹⁾	●	
97,50	±0,83			● ¹⁾	● ¹⁾	
100,00	±0,84			●	●	
103,00	±0,87			●	●	
106,00	±0,89			●	●	
109,00	±0,91			●	●	
112,00	±0,93			●	●	
115,00	±0,95			●	●	
118,00	±0,97			● ¹⁾	●	
122,00	±1,00			●	●	
125,00	±1,03			● ¹⁾	●	
128,00	±1,05			●	● ¹⁾	
132,00	±1,08			● ¹⁾	●	
136,00	±1,10			● ¹⁾	●	
140,00	±1,13			● ¹⁾	● ¹⁾	
145,00	±1,17			● ¹⁾	●	
150,00	±1,20			● ¹⁾	●	
155,00	±1,24			● ¹⁾	●	
160,00	±1,27			● ¹⁾	●	
165,00	±1,31			● ¹⁾	●	
170,00	±1,34			● ¹⁾	●	
175,00	±1,38			●	●	
180,00	±1,41			●	●	
185,00	±1,44			● ¹⁾	●	
190,00	±1,48			● ¹⁾	● ¹⁾	
195,00	±1,51			● ¹⁾	● ¹⁾	
200,00	±1,55			● ¹⁾	●	
206,00	±1,59				●	●
212,00	±1,63				●	●
218,00	±1,67				●	●
224,00	±1,71				● ¹⁾	●
230,00	±1,75				●	●

¹⁾ Standard series tools available

Tbl. 16

d ₁		d ₂				
		±0,08	±0,09	±0,10	±0,13	±0,15
	Permis. dev.	1,80	2,65	3,55	5,30	7,00
236,00	±1,79				●	●
243,00	±1,83				●	●
250,00	±1,88				●	●
258,00	±1,93				●	●
265,00	±1,98				●	● ¹⁾
272,00	±2,02				●	● ¹⁾
280,00	±2,08				●	●
290,00	±2,14				● ¹⁾	● ¹⁾
300,00	±2,21				●	●
307,00	±2,25				●	●
315,00	±2,30				●	● ¹⁾
325,00	±2,37				●	●
335,00	±2,43				●	●
345,00	±2,49				●	●
355,00	±2,56				● ¹⁾	● ¹⁾
365,00	±2,62				●	●
375,00	±2,68				●	● ¹⁾
387,00	±2,76				●	●
400,00	±2,84				●	●
412,00	±2,91					●
425,00	±2,99					●
437,00	±3,07					●
450,00	±3,15					●
462,00	±3,22					●
475,00	±3,30					●
487,00	±3,37					●
500,00	±3,45					●
515,00	±3,54					●
530,00	±3,63					●
545,00	±3,72					● ¹⁾
560,00	±3,81					●
580,00	±3,93					●

¹⁾ Standard series tools available

Tbl. 16

d ₁		d ₂				
		±0,08	±0,09	±0,10	±0,13	±0,15
	Permis. dev.	1,80	2,65	3,55	5,30	7,00
600,00	±4,05					●
615,00	±4,13					●
630,00	±4,22					●
650,00	±4,34					●
670,00	±4,46					●

¹⁾ Standard series tools available

Tbl. 16

PRODUCTS

ISC O-RING

573

STATIC SEALS

Back-Up Ring SRA	575
Back-Up Ring SRI	576
Spiral Back-Up Ring SPR	577
Profiles for Static Applications	578
Usit-Rings U, UA, USF	584
Plug & Seal Plug Connections	586
Merkel Cover Seal PU 82	588
Merkel Cover Seal PU 83	590
Merkel Grafiflex® Cover Seal	592
Merkel Cover Lid Seal Type 6324	594
Sealing Cover GA, GSA	595
Merkel Grafiflex® 6501	597
Merkel Endless Packing Rings	598

ISC O-RING

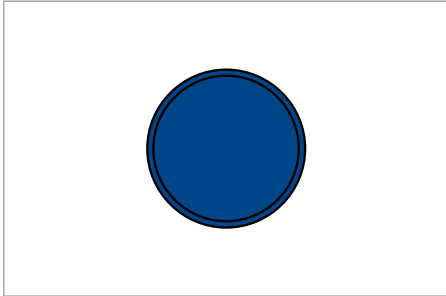

ISC O-Ring

PRODUCT DESCRIPTION

ISC O-Rings are endless round sealing rings of circular cross section. They are mainly used to seal stationary machine components – static case – against fluid and gaseous media. In certain conditions, they can also be used as a dynamic sealing component for axial, rotating and oscillating movement.

PRODUCT ADVANTAGES

- In order to cover the widest possible range of technical applications, ISC O-Rings are supplied in various different material qualities
- All catalogue materials for ISC O-Rings are specified and certified.

MATERIAL

Material	Operating parameters range
72 NBR 872	Standard material, which can be used for most applications (mineral oils, mineral oil based hydraulic fluids, static pressures up to approx. 100 bar)
88 NBR 156	Use as 72 NBR 872, but suitable for higher pressures.
80 FKM 610	For chemically aggressive media and high temperatures
70 EPDM 281	For glycol based hydraulic fluids, brake fluid, hot water
Simriz® (70 FFKM 495)	Chlorinated and high polar organic solvents, aromatics, Strong organic and inorganic acids and alkalis

The technical data for the standard materials for ISC O-Ring is specified.

Special materials: for special applications a broad spectrum of other materials is available from Simrit.

ISC O-Rings made of these materials are not held in stock.

DESIGN NOTES

The dimensions of an ISC O-Ring are defined by inside dia. d_1 and ring thickness d_2 . These dimensions represent the parameters for the ISC O-Ring. The code for an ISC O-Ring in standard material with inside dia. 20,2 mm and a ring thickness 3 mm is as follows: ISC O-Ring 20,2-3 72 NBR 872

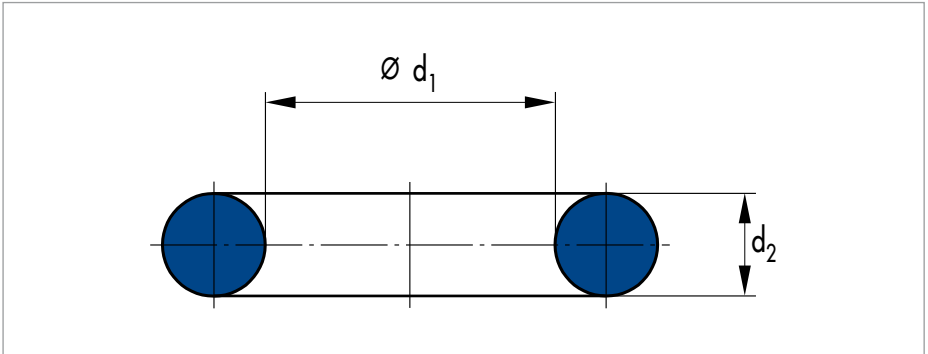

Drawing with dimensions

Please observe our general design notes.

Packaged unit

Delivery in standard packaging units of 5 - 10 - 20 - 50 - 100 units, depending on customer requirements.

BACK-UP RING SRA

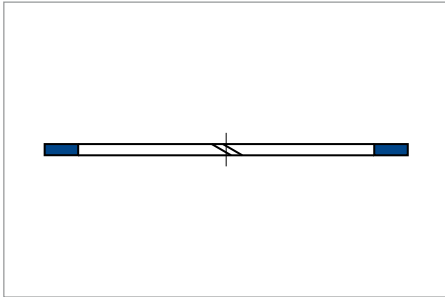

Back-Up Ring SRA

PRODUCT ADVANTAGES

- Enlargement of the operating conditions of O-rings
- High material and product quality
- Wide selection of standard dimensions.

PRODUCT DESCRIPTION

Slit bearing component with rectangular cross-section for ISC O-Rings sealing on the outside.

APPLICATION

Bearing element to prevent gap extrusion of radial sealing ISC O-Rings used dynamically.

MATERIAL

Material	Code
Unfilled PTFE	PTFE00/F52800 or PTFE 177509

OPERATING CONDITIONS

Media	Temperature
All fluids used in hydraulics	-70 ... +260 °C* (only valid for PTFE component)

* according to the O-ring material used

FITTING & INSTALLATION

The surface finish requirements correspond to the values stipulated. Gap width: when using PTFE spiral back-up rings, gap widths up to 0,3 mm can be bridged at operating pressures <40 MPa (400 bar).

BACK-UP RING SRI

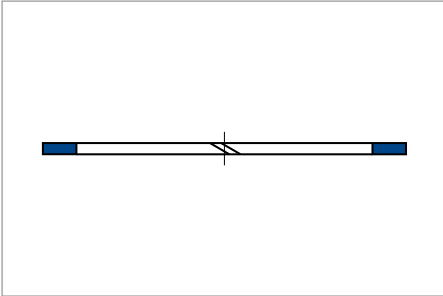

Back-Up Ring SRI

PRODUCT ADVANTAGES

- Enlargement of the operating conditions of O-rings
- High material and product quality
- Wide selection of standard dimensions.

PRODUCT DESCRIPTION

Slit bearing component with rectangular cross-section for ISC O-Rings sealing on the inside.

APPLICATION

Bearing element to prevent gap extrusion of radial sealing ISC O-rings used dynamically.

MATERIAL

Material	Code
Unfilled PTFE	PTFE00/F52800 or PTFE 177509

OPERATING CONDITIONS

Media	Temperature
All fluids used in hydraulics	-70 ... +260 °C* (only valid for PTFE component)

* according to the O-ring material used

FITTING & INSTALLATION

The surface finish requirements correspond to the values stipulated. Gap width: when using PTFE spiral back-up rings, gap widths up to 0,3 mm can be bridged at operating pressures <40 MPa (400 bar).

SPIRAL BACK-UP RING SPR

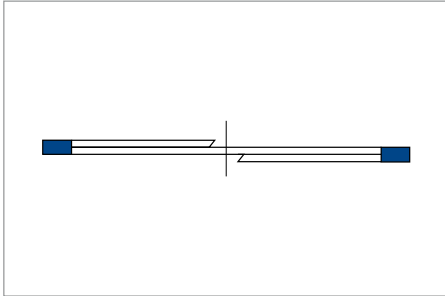

Spiral Back-Up Ring SPR

PRODUCT DESCRIPTION

Spiral-shaped split bearing component with rectangular cross section.

PRODUCT ADVANTAGES

Advantage compared to conventional back-up rings: Even in cases where considerable temperature fluctuations occur, i.e. if there is post-shrinkage of the back-up ring, at least one turn of the spiral will be left to support the ISC O-Ring over the gap at any point around the circumference.

Also suitable for non-standard diameters, as the ring can be shortened and thus adapted to fit.

APPLICATION

Bearing component to prevent gap extrusion of radial sealing ISC O-Rings.

MATERIAL

Material	Code
Unfilled PTFE	PTFE00/F52800 or PTFE 177509

OPERATING CONDITIONS

Media	Temperature
All fluids used in hydraulics	-70 ... +260 °C* (only valid for PTFE component)

* according to the O-ring material used

FITTING & INSTALLATION

The surface finish requirements correspond to the values stipulated. Gap width: when using PTFE spiral back-up rings, operating pressures ≤ 40 MPa (400 bar) or gap widths up to 0,3 mm can be bridged. Special sizes or special materials are available on enquiry.

PROFILES FOR STATIC APPLICATIONS

PRODUCT OVERVIEW

- Profiles
 - Hat Seals
 - X Profiles
 - Other special profiles
- Cords
 - Cord
 - Cord rings
- Hoses
 - Hoses
 - Hose rings.

- Low tool costs in comparison to shape related components
- Proprietary tool construction to ensure short supply times
- All common elastomers can be utilised
- Special materials competency
- Low number of pieces/amounts possible
- Profile rings in NBR and FKM are available with vulcanisation to butt. Advantages of batch vulcanisation:
 - Peak tensile strength values
 - Identical elastomer as connecting element provides long-lasting durability.

PRODUCT DESCRIPTION

Special profiles, cords or hoses are utilised whenever large sealing contact areas cannot be effectively sealed by form seals or O-rings, for example, in tunnelling machines, ships engines and hatchways. Over 3500 different profile nozzles as well as numerous materials area available. In addition, the development and production of customer-specific designs is possible, where the tool costs are very low compared to shape related components.

APPLICATION

- Components manufactured from profiles perform sealing tasks in numerous industrial sectors.
- Heavy-duty mechanical engineering, e.g. tunnel driving technology, cement/rock mills
 - Plant engineering, e.g. turbines, shut-off valves, process cylinders
 - Prime movers, e.g. ships' engine.

PRODUCT ADVANTAGES

- Sealing large seal contact areas that cannot be sealed by an O-ring or a shape related component
- Customer-specific product development

MATERIAL

Besides the common materials with shorter delivery times, numerous special materials are also offered. These feature outstanding quality and durability.

In the following overview, suitable materials can be selected according to their requirements.

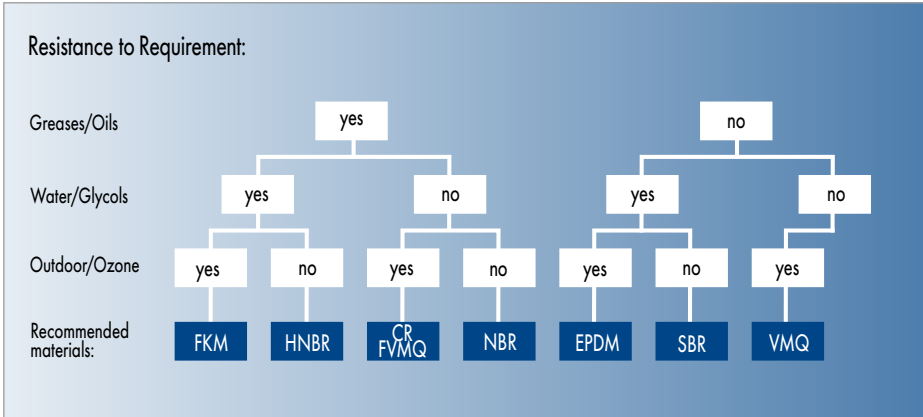

Material configuration

Material	Colour	Operating temperature range
50 NBR 121 *	Black	-30 ... +90 °C
60 NBR 122	Black	-30 ... +90 °C
70 NBR 221	Black	-25 ... +90 °C
70 NBR 803	Grey	-25 ... +90 °C
70 NBR 173216	Black	-30 ... +70 °C
72 NBR 872	Black	-30 ... +100 °C
79 NBR 105	Black	-30 ... +90 °C
80 NBR 709*	Black	-30 ... +90 °C
85 NBR 714	Black	-20 ... +90 °C
88 NBR 101	Black	-30 ... +100 °C
39 CR 174240*	Grey	-40 ... +80 °C
55 CR 852	Black	-40 ... +110 °C
67 CR 853	Black	-40 ... +110 °C
67 CR 215595	Black	-40 ... +80 °C
58 EPDM 215550	Grey	-40 °C ... +120 °C
70 EPDM 275	Black	-40 °C ... +120 °C
70 FKM 598	Green	-15 °C ... +200 °C
70 FKM 215450	Black	-10 °C ... +200 °C

Material	Colour	Operating temperature range
72 FKM 588	Black	-10 °C ... +200 °C
60 FVMQ 143026	Beige	-80 °C ... +175 °C
50 VMQ 570	Beige	-40 °C ... +200 °C
50 VMQ 114721	Yellow transparent	-40 °C ... +180 °C
58 VMQ 518	Red brown	-40 °C ... +200 °C
60 VMQ 114722	Yellow transparent	-40 °C ... +180 °C
70 VMQ 114723	Yellow transparent	-40 °C ... +180 °C
78 VMQ 526	Red	-40 °C ... +200 °C

* Special material on enquiry

DESIGN NOTES

Tolerances

All profiles, cords and hoses are manufactured according to DIN ISO 3302-1 E2. In exceptional cases, production according to E1 is also possible.

Limits for dimensions of cross sections of extruded components not supported (all dimensions in mm):

Nominal dimension		Tolerance class	
over	to	E1*	E2
0	1,5	0,15	0,25
1,5	2,5	0,20	0,35
2,5	4,0	0,25	0,40
4,0	6,3	0,35	0,50
6,3	10,0	0,40	0,70
10	16	0,50	0,80
16	25	0,70	1,00
25	40	0,80	1,30
40	63	1,00	1,60
63	100	1,30	2,00

* Partially possible in individual cases

X-PROFILES

X-Profiles are used for sealing rods, cylinders and housings. The lower compression required as a result of the four lip sealing profile makes them favourable to round profiles and results in cost advantages during installation. In addition, X-Profiles can easily be used in a rectangular groove thanks to their contour. The decisive advantage of the X-Profile is that the risk of tilting and twisting is minimised due to the larger bearing surface.

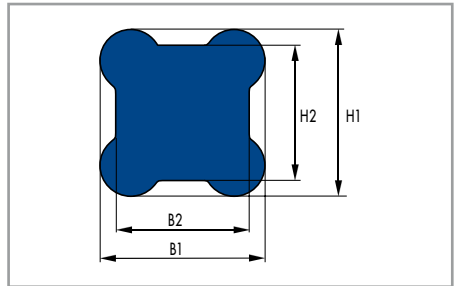

OTHER SPECIAL PROFILES

Profiles can be produced and supplied as follows:

- By the metre
 - With/without integral bend
- Profile sections
 - Produced to customer requirements (up to 2000 mm without integral bend possible)
- Profile rings
 - Bonded to butt or batch vulcanised.

Profile nozzles

Below is a selection of the 3500 profile nozzles in stock.

Individual tools can be developed and produced for special designs on enquiry. This normally takes around 4 weeks.

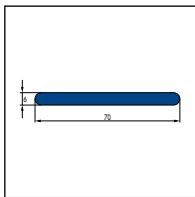

Profile 330

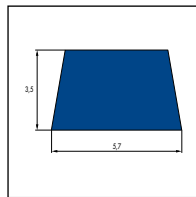

Profile 532

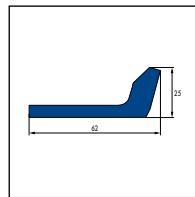

Profile 553

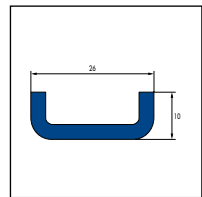

Profile 1235

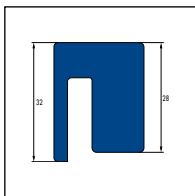

Profile 1775

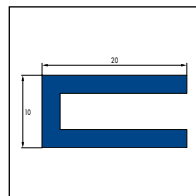

Profile 1930

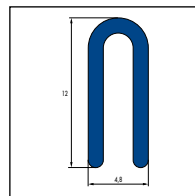

Profile 1966

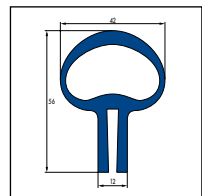

Profile 2018

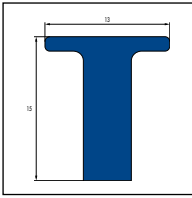

Profile 2028

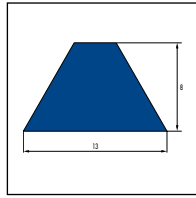

Profile 2130

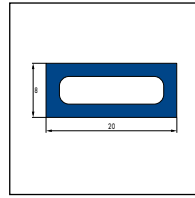

Profile 2295

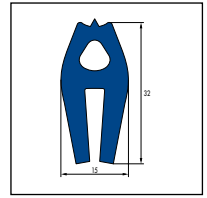

Profile 2584

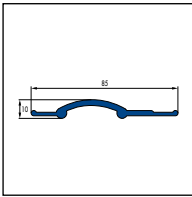

Profile 2766

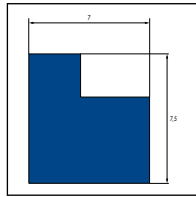

Profile 2817

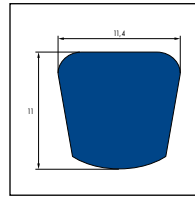

Profile 2956

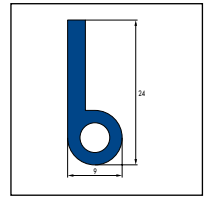

Profile 2976

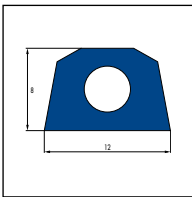

Profile 3009

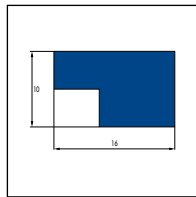

Profile 3058

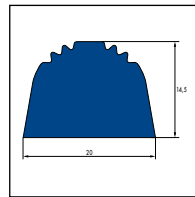

Profile 3225

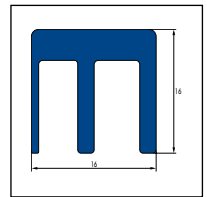

Profile 3261

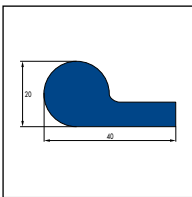

Profile 3274

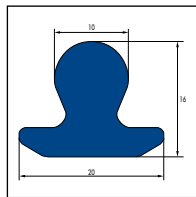

Profile 3387

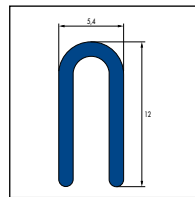

Profile 20116

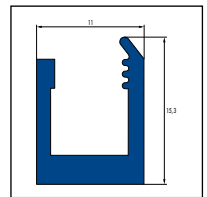

Profile 20121

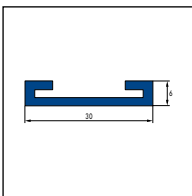

Profile 20124

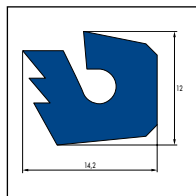

Profile 20128

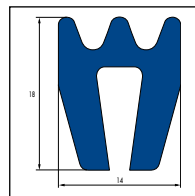

Profile 20141

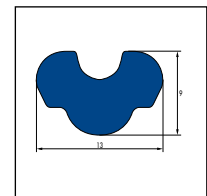

Profile 20162

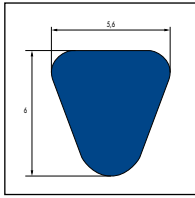

Profile 20163

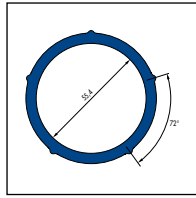

Profile 20189

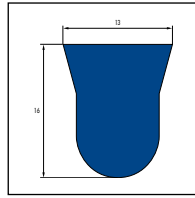

Profile 20197

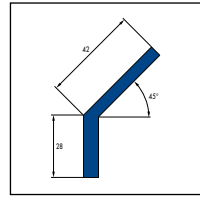

Profile 20211

CORD

The endless, extruded cord with O-ring profile serves as base material for cord rings, among others. These are used, for example, for the sealing of larger flanges or tank lids.

Range

- By the metre:
 - From 1 to 40 mm cord diameter available
- Cord sections:
 - Produced from cord supplied by the metre
 - From 1 to 40 mm cord diameter
 - Up to 2000 mm length without integral bend possible.

CORD RINGS

Cord rings are extruded cords, which are cut to the appropriate diameter and bonded or vulcanised to butt.

Range

Cord rings are produced from cord supplied by the metre. They are available with a cord diameter from 1 to 40 mm. A two-part adhesive can be used for bonding to butt. NBR and FKM product versions are available ex works with vulcanisation to butt.

Tolerances

The range of tolerances tends towards the negative side as a certain amount of elongation of rings with a large diameter is possible at any time during installation without causing an appreciable tapering of the cross section.

HOSE RINGS

Hose rings are rings punched from the hose and produced as hose by the metre. Hose rings made from precision hoses have absolute sharp inside and outside edges. The inside diameter is smooth and absolutely cylindrical. If necessary, a chamber and/or coloured marking is also possible.

Due to the special manufacturing process, a particularly good compression set is achieved.

Range

Hose rings are available always in agreement/on enquiry with a wall strength from 1 mm and up to an inside diameter of 200 mm.

USIT-RINGS U, UA, USF

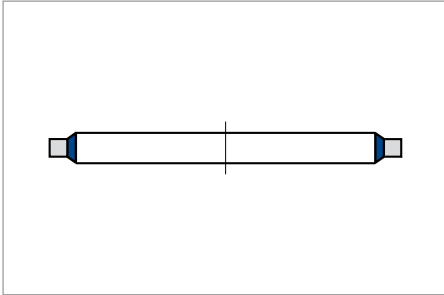

Usit-Ring U

PRODUCT DESCRIPTION

Metal gasket with internally (U) or externally (UA) vulcanised, trapezoidal, rubber-elastic sealing bead for static sealing of

- Threaded fittings
- Flange connections
- (USF) with centring diaphragm.

PRODUCT ADVANTAGES

- Easy fitting
- Force-fit connections
- Secure, self-reinforced sealing
- Suitable for high pressures.

APPLICATION

Sealing of threaded fittings and flange connections e.g. in mechanical engineering.

MATERIAL

Metal ring	Steel SPCC Steel SPCC-1B Stainless steel (SUS 304)
Sealing bead	NBR rubber 72 NBR 99041 FKM rubber 75 FKM 99104 Other materials are available on enquiry from special production.
Surface protection metal ring	SPCC/NBR zinc chrome plated (CR VI free coating) SPCC-1B/NBR zinc chrome plated (CR VI free coating) SPCC/FKM phosphated SPCC-1B/FKM phosphated

OPERATING CONDITIONS

NBR

Media	Mineral oils (as per DIN 51524), hydraulic fluids HFA, HFB, HFC (as per VDMA 24320)
Temperature	-30 ... +100 °C

FKM

Media	Hot air (+250 °C) Mineral oils (as per DIN 51524, +150 °C) Hydraulic fluids (as per VDMA 24320, +150 °C)
Operating pressure	<100 MPa (installation in counter bore) <40 MPa (installation without counter bore for Ø <40 mm; only USF) <25 MPa (installation without counter bore for Ø <40 mm)

DESIGN NOTES

Installation

Surface	Flat surfaces	$R_{max} \leq 15 \mu\text{m}$ $R_a \leq 3 \mu\text{m}$
----------------	---------------	---

Tolerances on finished parts

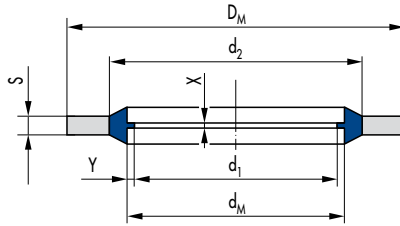

Tolerance	D_M	d_M		s
≤ 28	$+0,15/-0,10$	$+0,10/-0,20$	1,0	$+0,08/-0,15$
28 – 50	$+0,20/-0,10$	$+0,10/-0,30$	1,5	$+0,13/-0,20$
> 50	$+0,25/-0,10$	$+0,10/-0,40$	2,0	$+0,13/-0,20$
			3,0	$+0,20/-0,25$
			3,5	$+0,20/-0,30$

PLUG & SEAL PLUG CONNECTIONS

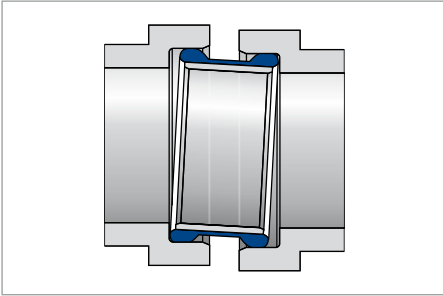

Plug & Seal Plug Connections

PRODUCT DESCRIPTION

Plug & Seal Plug Connections are pipe sections with a rubberised outer surface with sealing beads and stop dampers.

They are used to establish a tight connection between two housings or units - and for secure transport of media such as oils, water or air.

As well as standard design Plug & Seal products, Simrit also offers individual solutions tailored to specific customer applications.

PRODUCT ADVANTAGES

- Reliable sealing even under high pressures
- Simple, secure and cost-effective installation
- Acoustic and mechanical decoupling
- Reduced amount of maintenance through improved durability

- Compensation of middle offset
- Large tolerances in installation permissible
- Lower logistical complexity
- Integration of multiple functions into one component
- Low total costs.

APPLICATION

- Water and oil circulation or ventilation systems for combustion engines
- Engine auxiliaries, such as compressors, turbochargers or intake manifolds
- Manual and automatic transmissions
- Valves and pipe systems
- Heating and climate-control systems of plants and buildings.

MATERIAL

Tube	Precision steel (min. St 35, phosphatised) Aluminium, plastic on enquiry
Seal	EPDM, FKM rubber AEM, ACM, NBR, HNBR, VMQ on enquiry

OPERATING CONDITIONS

Operating pressure	max. 10 bar
---------------------------	-------------

Higher pressures on enquiry.

Elastomer	Media	Temperature	Possible Applications
EPDM	Not oil-resistant	-40 ... +140 °C	Cooling water, brake fluid, aqueous media
FKM	Oil-resistant	-10 ... +220 °C	Charge air with oil components, cooling water, fuels such as diesel, biodiesel, petrol
VMQ	Oil-resistant	-40 ... +220 °C	Charge air with oil components, intake air
AEM	Oil-resistant	-25 ... +150 °C	Charge air with oil components, engine oil
ACM	Oil-resistant	-25 ... +150 °C	Engine oil
NBR	Oil-resistant	-30 ... +90 °C	Gear oil
HNBR	Oil-resistant	-30 ... +140 °C	Gear oil, engine oil, diesel fuel

FITTING & INSTALLATION

Specifications for finish of housing:

- Surface roughness R:
 - Static pressures
 $R_{\max} < 16 \mu\text{m}$,
 - Pulsating pressures
 $R_{\max} < 6 \mu\text{m}$
- Tolerance ISO H8
- Recommended lead-in chamfers:
 - Chamfer min. 20°,
 - Chamfer length (a) ca. 2 mm,
 - Edges free of burrs and rounded
- Depth of housing (f1): $\geq 7 \text{ mm}$
- Max. axial offset by consultation.

MERKEL COVER SEAL PU 82

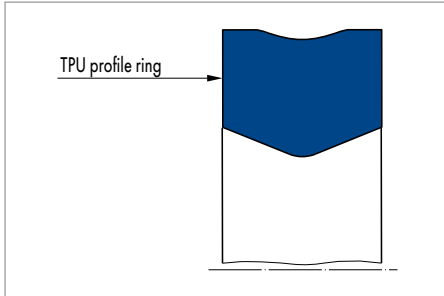

Merkel Cover Seal PU 82

PRODUCT DESCRIPTION

Single-piece, double-acting compact seal made from TPU for static sealing, inner sealing.

PRODUCT ADVANTAGES

- Interchangeable for O-ring housings and O-ring with back-up ring
- High reliability
- Simple and secure installation
- Simplified stockkeeping
- Gas proofness.

APPLICATION

- Higher operating pressure (up to 60 MPa)
- Gap for breathing (pipe expansion)
- Short rate of increase of the pressure (end position damping)
- Alternating in situ operating pressure
- Nominal diameter up to 2000 mm.

Cranes, construction machinery, industrial vehicles, forestry equipment, injection moulding machines, presses, wind power plants.

MATERIAL

Material	Code
Polyurethane	95 AU V142/94 AU 925

OPERATING CONDITIONS

Material	95 V142/94 AU 925
	Temperature range in °C
Hydraulic oils HL, HLP	-30 ... +110
HFA fluids	+5 ... +50
HFB fluids	+5 ... +50
HFC fluids	-30 ... +40
HFD fluids	-
Water	+5 ... +40
HETG (rapeseed oil)	-30 ... +60
HEES (synthetic ester)	-30 ... +80
HEPG (glycol)	-30 ... +50
Mineral greases	-30 ... +110
Pressure p in MPa	60

The specified values are maximum values and must not be applied simultaneously.

Surface quality

Surface roughness	R_a	R_{max}
Sliding surface	0,8 μm	3,2 μm
Groove base	1,6 μm	6,3 μm
Groove flanks	6,3 μm	20,0 μm
Lead-in chamfer*	0,8 μm	3,2 μm

* burr-free transition

DESIGN NOTES

Please observe our general design notes.

Tolerance recommendation

For pressures up to 60 MPa

Nominal \varnothing d	Borehole	Shaft
≤ 800	H7	f7
> 800	+0,0 +0,1	-0,05 -0,15

FITTING & INSTALLATION

Careful fitting is a prerequisite for the correct function of the seal.

MODE OF OPERATION

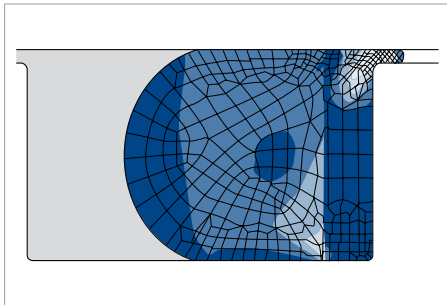

O-ring with PTFE back-up ring at 40 MPa operating pressure

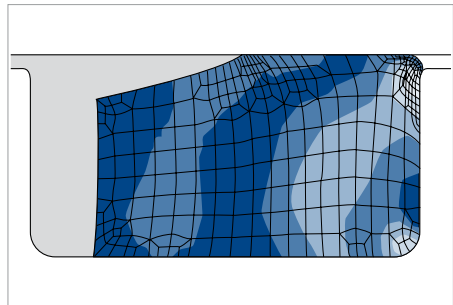

Cover Seal at 40 MPa operating pressure

MERKEL COVER SEAL PU 83

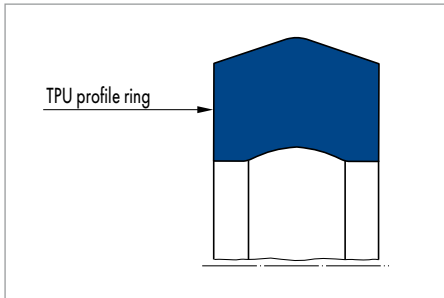

Merkel Cover Seal PU 83

PRODUCT DESCRIPTION

Single-piece, double-acting Merkel compact seal made from low temperature polyurethane for static sealing, outer sealing.

PRODUCT ADVANTAGES

- Interchangeable for O-ring housings and O-ring with back-up ring
- High reliability
- Simple and secure installation
- Simplified stockkeeping
- Gas-proof height.

APPLICATION

- Higher operating pressure (up to 60 MPa)
- Gap for breathing (pipe expansion)
- Short rate of increase of the pressure (end position damping)
- Alternating in situ operating pressure
- Nominal diameter up to 2000 mm.

Presses, steel industry, wind power plants, cranes, construction machinery, industrial vehicles, forestry equipment, injection moulding machines.

MATERIAL

Material	Code
Polyurethane	95 AU V142/94 AU 925

OPERATING CONDITIONS

Material	95 V142/94 AU 925
	Temperature range in °C
Hydraulic oils HL, HLP	-30 ... +110
HFA fluids	+5 ... +50
HFB fluids	+5 ... +50
HFC fluids	-30 ... +40
HFD fluids	-
Water	+5 ... +40
HETG (rapeseed oil)	-30 ... +60
HEES (synthetic esters)	-30 ... +80
HEPG (glycol)	-30 ... +50
Mineral greases	-30 ... +110
Pressure p in MPa	60

The specified values are maximum values and must not be applied simultaneously.

Surface quality

Surface roughness	R_a	R_{max}
Sliding surface	0,8 μm	3,2 μm
Groove base	1,6 μm	6,3 μm
Groove flanks	6,3 μm	20,0 μm
Lead-in chamfer*	0,8 μm	3,2 μm

* burr-free transition

DESIGN NOTES

Please observe our general design notes.

Tolerance recommendation

For pressures up to 60 MPa

Nominal Ø D	Borehole	Shaft
≤800	H7	f7
>800	+0,0 +0,1	-0,05 -0,15

FITTING & INSTALLATION

Careful fitting is a prerequisite for the correct function of the seal.

MODE OF OPERATION

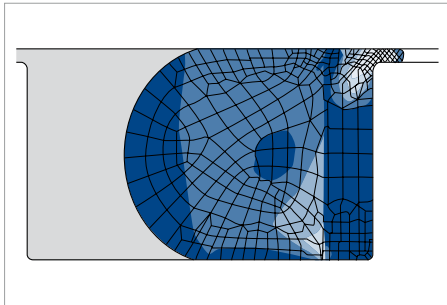

O-ring with PTFE back-up ring at 40 MPa operating pressure

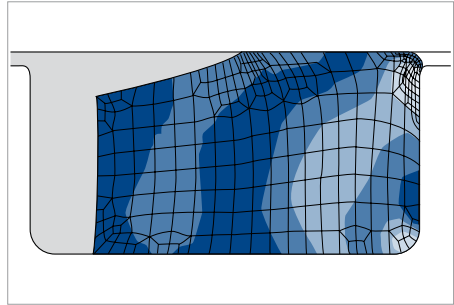

Cover Seal at 40 MPa operating pressure

MERKEL GRAFIFLEX®-COVER SEAL

PRODUCT DESCRIPTION

Merkel Grafiflex cover seals are supplied as pre-pressed rings and are proven in self-sealing covers, e.g. in large valves and in high-pressure water pre-heaters.

PRODUCT ADVANTAGES

Merkel Grafiflex stays elastic even with continually varying temperature and pressure up to 200 N/mm² surface pressure. It correctly bridges gap widths on large, self-sealing covers up 0,3 mm. Larger gaps are controlled by Merkel Grafiflex using springs made of material 1.4571 integrated into the corners of the packing rings by pressing.

APPLICATION

Valves.

OPERATING CONDITIONS

Operating pressure	Temperature	pH value
1000 bar	-200 ... +550 °C ¹⁾	0 ... 14
	-200 ... +700 °C ²⁾	
	-200 ... +2500 °C ³⁾	

¹⁾ the majority of media and air

²⁾ steam

³⁾ inert gas

Media

Hot water, feed water, steam, heat transfer oil, hydro-carbons and many other media. Exceptions: strongly oxidising media.

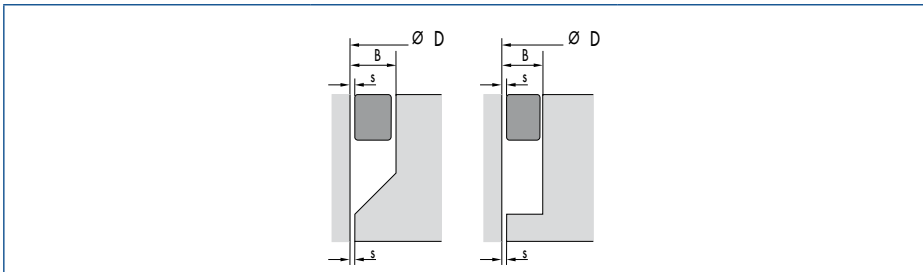
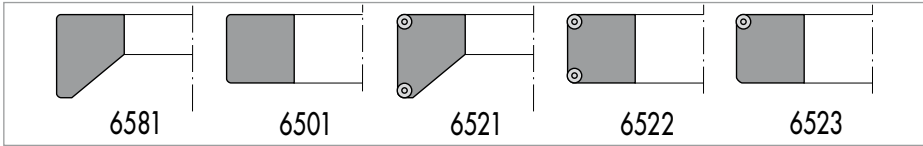

Ø D	B	S _(centr.)
350	20	0,8
350	>20	1,2
>350	20	0,8
>350	25	1,2
>350	>25	1,5

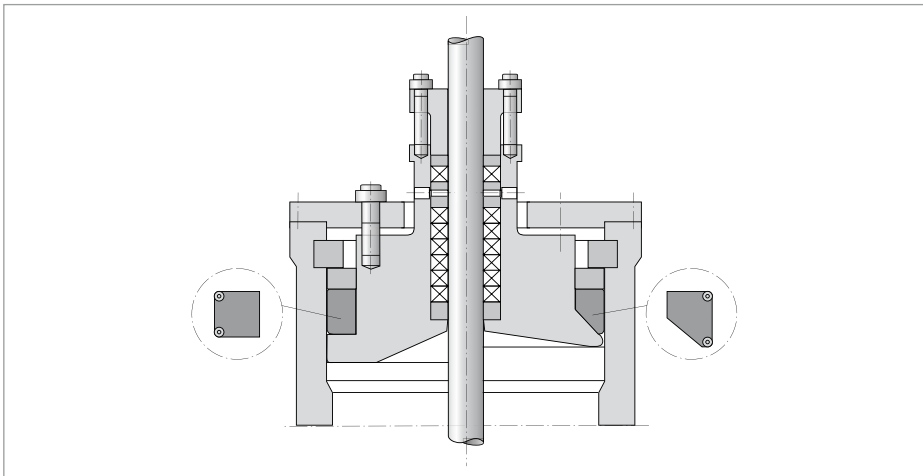

MERKEL COVER LID SEAL TYPE 6324

PRODUCT DESCRIPTION

The Merkel Cover Lid Seal Type 6324 consists of a concentric hose braid and an optional elastomer core.

The elastomer core guarantees a constant sealing force over the entire service life. This is ideal for static cover seals with a high number of open/close cycles. The outer braid provides good wear protection and protects against attacks by chemicals.

PRODUCT ADVANTAGES

- Low leakage
- Increased elasticity and spring back
- Good chemical resistance.

APPLICATION

Cover and housing seals, tank covers, manholes, filters, dryers, chemical mixer housings, rotary valves, rotary furnaces.

MATERIAL

Yarn	Elastomer core	Impregnation
PTFE	EPDM, MVQ	PTFE

OPERATING CONDITIONS

Operating pressure	Temperature	Speed	pH value
10 bar	-30 ... +250 °C	2 m/s*	0 ... 14

* depending on material combination

SEALING COVER GA, GSA

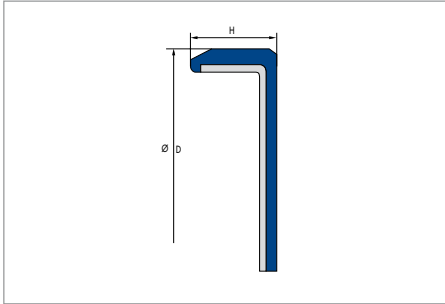

Sealing Cover GA

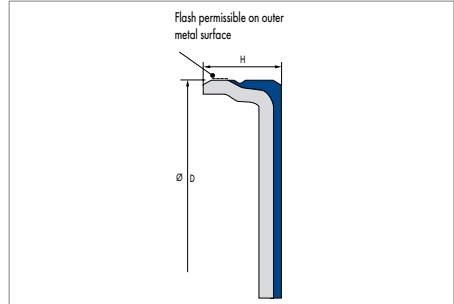

Sealing Cover GSA

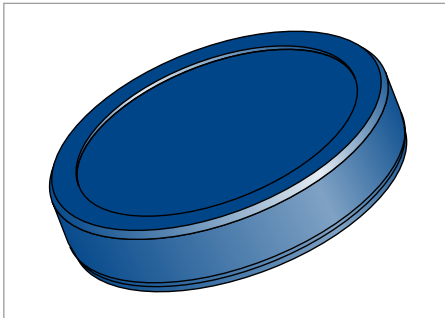

Sealing Cover GA – Top view

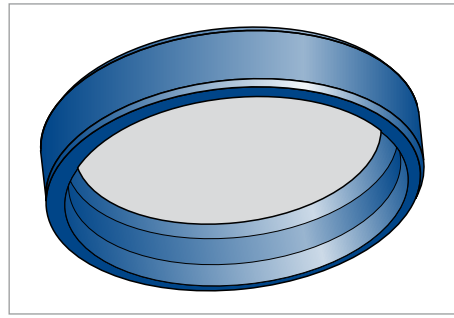

Sealing Cover GA – Bottom view

PRODUCT DESCRIPTION

- GA (normal design, rubber outside): sealing cover with vulcanised metal inserts made of sheet steel
- GSA (special design, rubber/steel outside): sealing cover with vulcanised metal inserts made of sheet steel with metal seat (H8).

PRODUCT ADVANTAGES

- Secure sealing to the housing bore, even with increased roughness of the bore, higher thermal expansion and split housings
- Very stable construction
- Can be painted
- Variety of standard versions.

APPLICATION

Sealing cover for the static sealing of boreholes in housings with press fitting e.g. shaft pass through walls in gearbox housings.

MATERIAL

Acrylonitrile-butadiene rubber

Designation	75 NBR 99004
Colour	Black
Hardness	approx. 75 Shore A
Metal insert	unalloyed steel DIN EN 10139 (DIN 1624)

Sealing covers made of other materials and in other dimensions available on enquiry.

OPERATING CONDITIONS

Media	All common mineral oils
Temperature	-40 ... +100 °C

FITTING & INSTALLATION

Design of locating bore

Tolerance	ISO H8
Roughness type GA	$R_{\max} \leq 25 \mu\text{m}$ $R_a = 1,6 \dots 6,3 \mu\text{m}$ $R_z = 10 \dots 25 \mu\text{m}$
Roughness type GSA	$R_{\max} \leq 16 \mu\text{m}$ $R_a = 0,8 \dots 3,2 \mu\text{m}$ $R_z = 6,3 \dots 16 \mu\text{m}$

MERKEL GRAFIFLEX® 6501

PRODUCT DESCRIPTION

Merkel Grafiflex is characterised by the highest level of chemical resistance and temperature resistance as well as an excellent sealing effect and persistent elasticity. Regardless of temperature cycle, there is no cold flow, shrinkage or ageing of the material. Merkel Grafiflex meets the purity requirements for seals in nuclear power station valves (content of soluble chlorides <20 ppm).

Merkel Grafiflex rings

Compression moulded Merkel Grafiflex rings are supplied with a density between 1,4 and 1,85 g/cm³.

Merkel Grafiflex Strip

Merkel Grafiflex Strip with crosshatch surface pattern is used to make rings in the event of repairs. The Grafiflex material is approved for use with gaseous oxygen,

drinking water and for the food processing industry. Like Grafiflex 6509, it is also available with corrosion inhibitor.

For reworked valves with large gap dimensions, the use of Merkel Grafiflex with Merkel Carbosteam 6550 endrings is recommended.

PRODUCT ADVANTAGES

- Very high temperature and chemical resistance
- Excellent sealing effect and constant elasticity
- Fast delivery times without additional tool costs.

APPLICATION

Valves.

OPERATING CONDITIONS

Operating pressure	Temperature	pH value
1000 bar	-200 ... +450 °C ¹⁾	0 ... 14
	-200 ... +700 °C ²⁾	
	-200 ... +2500 °C ³⁾	

¹⁾ the majority of media and air

²⁾ steam

³⁾ inert gas

Media

Hot water, feed water, steam, heat transfer oil, hydro-carbons and many other media. Exceptions: strongly oxidising media.

MERKEL ENDLESS PACKING RINGS

PRODUCT DESCRIPTION

Simrit manufactures endless packing rings in a whole variety of materials and dimensions. The sealing rings consist of a concentric hose braid and an optional elastomer core. The elastomer core guarantees a constant sealing force over the entire service life. This is ideal for static cover seals with a high number of open/close cycles. The outer braid provides good wear protection and protects against attacks by chemicals.

Endless packing rings can also be used for many applications with minor active movements.

Various yarn, core and impregnation combinations offer the ideal seal for a whole variety of applications.

PRODUCT ADVANTAGES

- Low leakage
- Increased elasticity and spring back
- Good chemical resistance.

APPLICATION

Cover and housing seals, tank covers, manholes, filters, dryers, chemical mixer housings, rotary valves, rotary furnaces.

MATERIAL

Yarn	Yarn or elastomer core	Impregnation
Ramie, aramide, PTFE, PTFE/ graphite compounds, carbon	NR, EPDM, MVQ	PTFE, graphite

OPERATING CONDITIONS

Operating pressure	Temperature	Speed	pH value
10 bar*	-30 ... +550 °C*	2 m/s*	0 ... 14*

* depending on material combination

